

GA500 Quick Setup Procedure for Models GA50UB001 to B018, 2001 to 2082, and 4001 to 4060

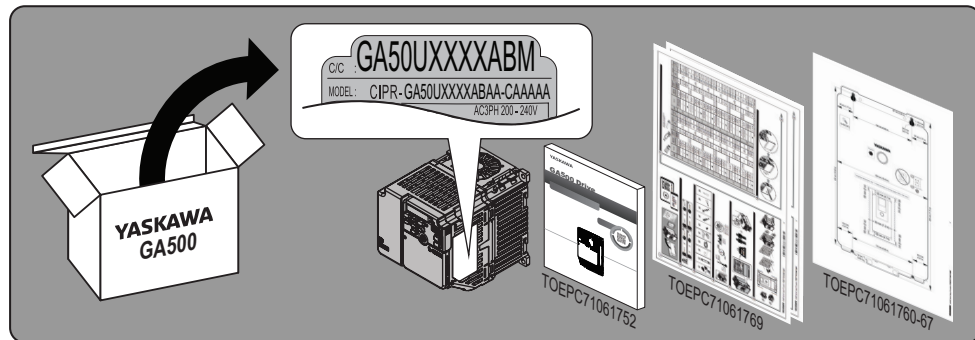

1 Confirm the Drive and Motor Specifications

VOLTS ≥ **VOLTS** **AMPS** ≥ **AMPS**
HP ≥ **HP** **HERTZ** ≥ **HERTZ**

2 Collect the Required Tools and Equipment

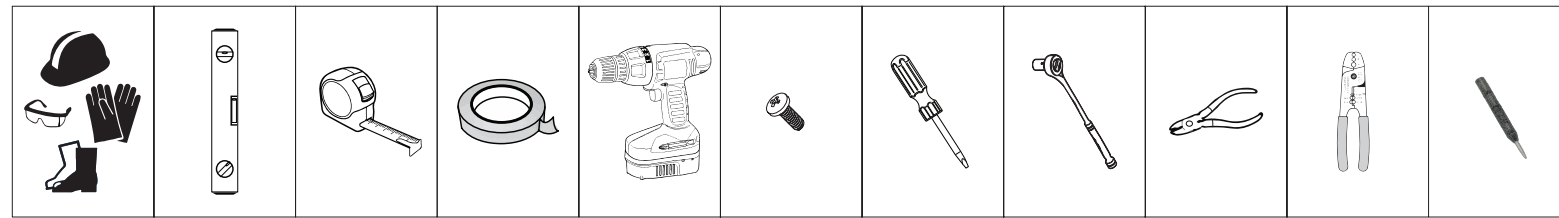

3 Confirm the Correct Drive Installation Environment

*Refer to the drive manual for installations exceeding these conditions.

4 Mount the Drive

5 Select the Correct Branch Circuit Protection, Wires, and Wire Strip Length, and Tightening Torque

UL Compliance: Install one of these types of short circuit protection devices to comply with UL 61800-5-1. Semiconductor protective type fuses are recommended, but the table also shows alternative short circuit protection devices. When you use MCCBs, RK1, or RK5 fuses, you must mount the drive in a ventilated enclosure as according to the minimum enclosure volume specified in this document.

MCCB and Non-Semiconductor Fuse Ratings: Maximum MCCB rating is 200% of the Normal-Duty drive full load output amp (FLA) rating. Maximum CC, J, T, RK1, or RK5 fuse rating is 175% of the Normal-Duty drive full load output amp (FLA) rating. You can substitute an alternate UL listed current limiting type MCCB where the peak let-through current and I²t of the alternate MCCB is not greater than the specified MCCB in this table.

Short Circuit Current Rating (SCCR): The maximum SCCR provided by drive and fuse, or drive and MCCB combinations in this document, is 31,000 RMS symmetrical amps. Use the protection specified in this document to prepare the drive for use on a circuit capable of delivering not more than 31,000 RMS symmetrical amps and not more than 240 Vac (240 V models) and 480 Vac (480 V models) when there is a short circuit in the power supply.

Model	R/L1 or L/L1, S/L2 or N/L2, T/L3		U/T1, V/T2, W/T3		-, +1, +2		B1, B2		⊕		mm (in)	Semiconductor Fuse Manufacturer: Eaton/Bussmann Part Number	Class CC, J, or T Fuse Maximum Amps					
	Wire AWG*1	Torque N·m (lbf·in) Screw Size	Wire AWG*1	Torque N·m (lbf·in) Screw Size	Wire AWG*1	Torque N·m (lbf·in) Screw Size	Wire AWG*1	Torque N·m (lbf·in) Screw Size	Wire AWG*1	Torque N·m (lbf·in) Screw Size								
Single-Phase 240 V																		
B001	14 (14)	0.5 - 0.6 (4.4 - 5.3) ⊖ M3	14 (14)	0.5 - 0.6 (4.4 - 5.3) ⊖ M3	14 (14)	0.5 - 0.6 (4.4 - 5.3) ⊖ M3	14 (14)	0.5 - 0.6 (4.4 - 5.3) ⊖ M3	14 (14)	0.8 - 1.0 (7.1 - 8.9) ⊕ M3.5	6.5 (0.26)	FWH-25A14F	3.5					
B002																FWH-25A14F	6	
B004																	FWH-60B	12
B006	14 - 10 (12)				14 - 12 (14)				14 - 10 (12)				14 - 12 (14)		14 - 10 (10)	1.2 - 1.5 (10.6 - 13.3) ⊕ M4	8 (0.3)	FWH-80B
B010	12 - 10 (10)		14 - 10 (12)		12 - 10 (10)		14 - 8 (8)		14 - 10 (10)	2.0 - 2.5 (17.7 - 22.1) ⊕ M5	10 (0.4)	FWH-100B	35					
B012	14 - 8 (8)		14 - 10 (12)		14 - 8 (8)		14 - 8 (8)		14 - 8 (8)				FWH-125B	40				
B018	12 - 6 (8)		14 - 8 (10)		12 - 6 (8)		12 - 6 (8)		12 - 8 (8)			FWH-150B	60					
Three-Phase 240 V																		
2001	14 (14)	0.5 - 0.6 (4.4 - 5.3) ⊖ M3	14 (14)	0.5 - 0.6 (4.4 - 5.3) ⊖ M3	14 (14)	0.5 - 0.6 (4.4 - 5.3) ⊖ M3	14 (14)	0.5 - 0.6 (4.4 - 5.3) ⊖ M3	14 (14)	0.8 - 1.0 (7.1 - 8.9) ⊕ M3.5	6.5 (0.26)	FWH-25A14F	2					
2002																FWH-25A14F	3.2	
2004																	FWH-25A14F	6
2006																	FWH-25A14F	10
2010	14 - 12 (14)		14 - 12 (14)		14 - 10 (12)		14 - 12 (14)		14 - 10 (10)	1.2 - 1.5 (10.6 - 13.3) ⊕ M4	8 (0.3)	FWH-70B	15					
2012	14 - 10 (12)		14 - 10 (12)		12 - 10 (10)		14 - 8 (8)		14 - 8 (8)				FWH-70B	20				
2021	14 - 8 (8)		14 - 8 (8)		14 - 8 (8)		14 - 8 (8)		14 - 8 (8)	2.0 - 2.5 (17.7 - 22.1) ⊕ M5	10 (0.4)	FWH-90B	35					
2030	12 - 6 (8)		12 - 6 (8)		12 - 6 (6)		12 - 8 (12)		10 - 6 (8)				FWH-100B	50				
2042	12 - 6 (6)		12 - 6 (6)		10 - 2 (4)		14 - 6 (10)		10 - 6 (6)			FWH-150B	70					
2056	10 - 2 (4)		10 - 2 (4)		8 - 2 (2)		12 - 6 (8)		8 - 4 (6)	5.4 - 6.0 (47.8 - 53.1) ⊕ M6	18 (0.71)*3	FWH-200B	90					
2070	6 - 1 (2)		8 - 1 (2)		6 - 1/0 (1)		10 - 6 (6)		6 - 4 (4)				FWH-200B	110				
2082	6 - 1/0 (1)		6 - 1 (2)		2 - 2/0 (2/0)		10 - 6 (6)					FWH-225B	125					
Three-Phase 480 V																		
4001		0.5 - 0.6 (4.4 - 5.3) ⊖ M3		0.5 - 0.6 (4.4 - 5.3) ⊖ M3		0.5 - 0.6 (4.4 - 5.3) ⊖ M3		0.5 - 0.6 (4.4 - 5.3) ⊖ M3		1.2 - 1.5 (10.6 - 13.3) ⊕ M4	8 (0.3)	FWH-40B	2					
4002																FWH-40B	3.5	
4004	14 - 12 (14)				14 - 12 (14)				14 - 12 (14)				14 - 12 (14)		14 - 10 (10)		FWH-50B	7
4005															14 - 10 (10)		FWH-70B	9
4007											FWH-70B	12						
4009											FWH-90B	15						
4012	14 - 10 (12)				12 - 8 (10)		14 - 6 (10)		14 - 6 (10)	2.0 - 2.5 (17.7 - 22.1) ⊕ M5	10 (0.4)	FWH-90B	20					
4018	12 - 8 (10)		12 - 8 (10)		14 - 8 (10)		12 - 8 (10)		10 - 6 (10)				FWH-80B	30				
4023	14 - 6 (8)		14 - 8 (10)		12 - 6 (8)		10 - 6 (8)		10 - 6 (8)			FWH-100B	40					
4031	12 - 6 (8)		12 - 6 (8)		12 - 4 (6)		14 - 6 (10)		10 - 6 (8)			FWH-125B	50					
4038	12 - 6 (6)		12 - 6 (8)		10 - 2 (4)		14 - 6 (10)					FWH-175B	60					
4044	10 - 2 (4)		12 - 4 (6)		8 - 2 (2)		12 - 6 (8)		10 - 6 (6)	5.4 - 6.0 (47.8 - 53.1) ⊕ M6	18 (0.71)*3	FWH-200B	75					
4060	8 - 2 (2)		10 - 2 (4)		6 - 2 (2)								FWH-200B	100				

*1 Values in bold parentheses are the recommended values.

*2 Strip length for terminals -, +1, +2 is 18 mm (0.71 in).

*3 Strip length for terminals B1, B2 is 10 mm (0.4 in).

6 Install the Motor Wiring

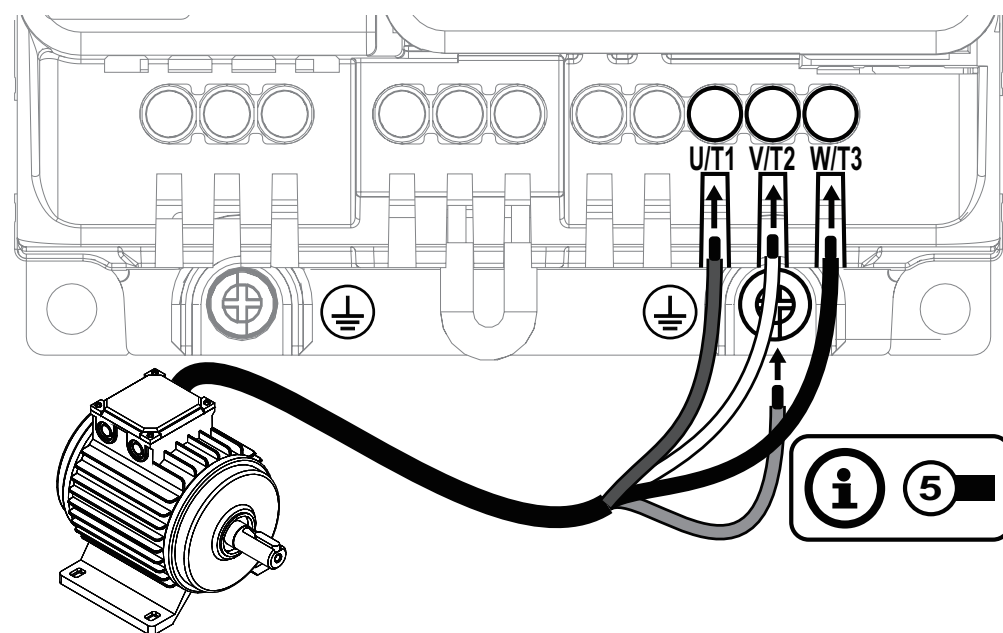

7 Install the Power Wiring

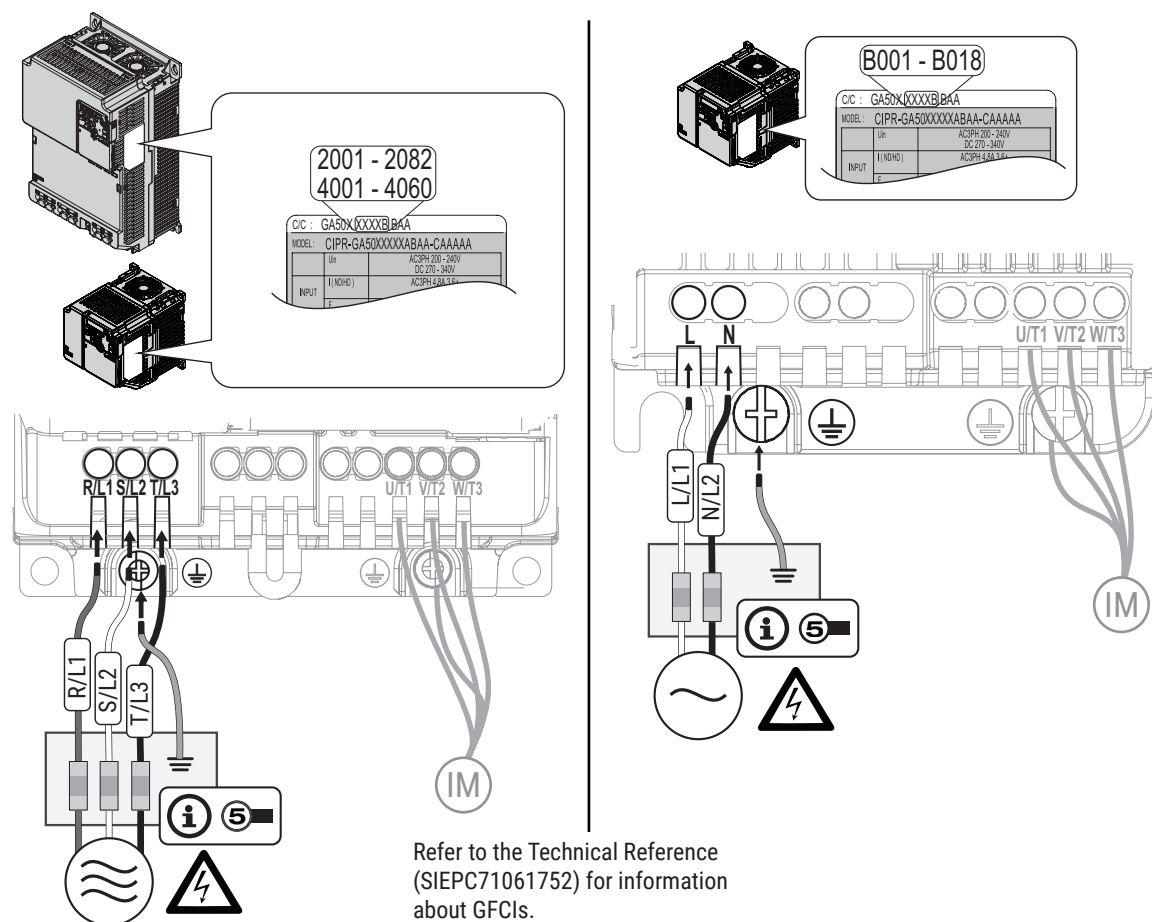

8 Determine the Correct Auto-Tuning Method

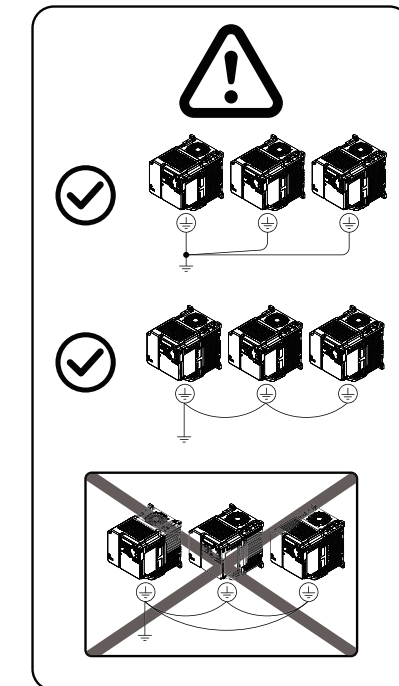
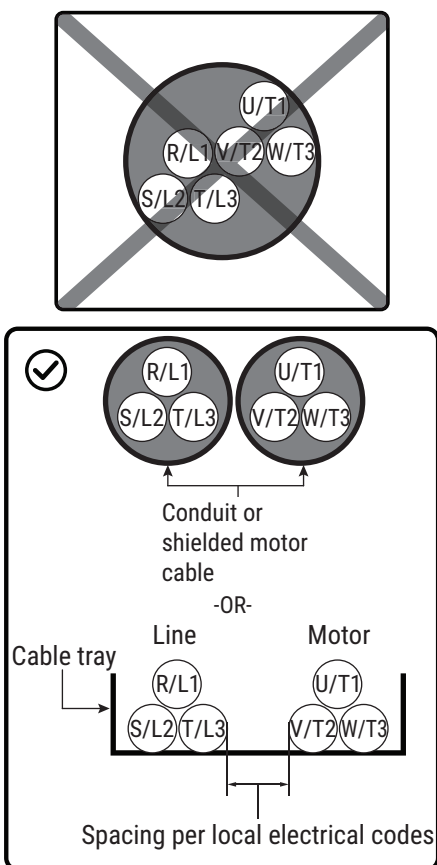
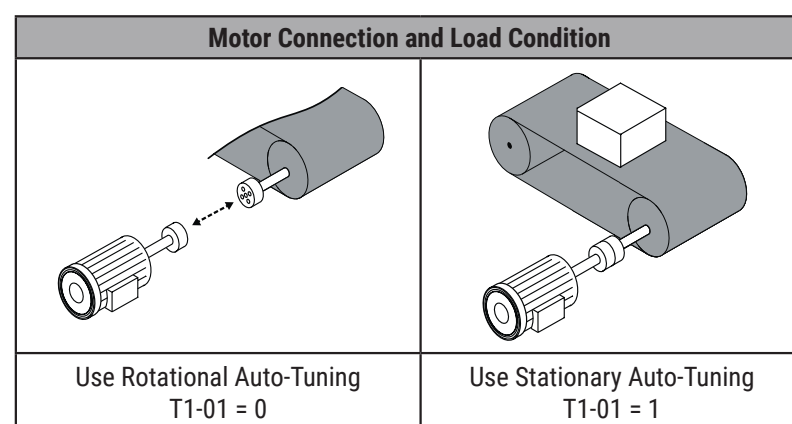

9 Collect and Record Auto-Tuning Data from Motor Nameplate

3 PHASE INVERTER DUTY AC INDUCTION MOTOR NAMEPLATE EXAMPLE

MODEL XX	123AAAA123XX-X0	X	FRAME 123AX
POLES X	ENC XXX	CODE X	DES A
VOLTS XXX	FL RPM XXXX	FL AMPS XX/XX	TYPE ABC INS X0
SF 1.0	DUTY CONT	MAX AMB °C XX	TEMP. SENSORS T-STATS
SERIAL		N.L. AMPS XX.X/X.X	
MAX RPM 4200	S.E. BRG. 309	O.S.E. BRG. XXX	ROTOR WK² X.X
HZ	HP	RPM	TORQUE (LB FT)
1	-	0	XX.X
60	XX	XXXX	XX.X
T20	XX	XXXX	XX.X
OHMS PH.	R1: .XXX	R2: .XXX	X1: X.XX
			X2: X.XX
			XM: XX.X

P/N XXXXXXX

Reference	T1-xx Parameter (Ex-xx Parameter*)	Motor Nameplate Data	Motor Nameplate Value
A	T1-02 (E2-11)	Motor Rated Power	(HP x 0.746) kW
B	T1-03 (E1-05)	Motor Rated Voltage	V
C	T1-04 (E2-01)	Motor Rated Current (FLA)	A
D	T1-05 (E1-04/E1-06)	Motor Rated Frequency (Base Frequency)	Hz
E	T1-06 (E2-04)	Motor Pole Count	-
F	T1-07	Motor Rated RPM	RPM
G	T1-09 (E2-03)	Motor No-Load Current*2	A
-	T1-10 (E2-02)	Motor Rated Slip*2*3	0.000 Hz
-	T1-12	Test Mode Selection*2	-
-	T1-13	Motor No-Load Voltage	V

*1 Auto-Tuning will automatically set the E1-xx and E2-xx parameters. You can manually adjust Ex-xx parameters after Auto-Tuning.
*2 These values are only necessary for Stationary Auto-Tuning (T1-01 = 1).
*3 If you do not know this value, leave at the default value of 0.000.

10 Energize the Drive and Confirm It Is Ready

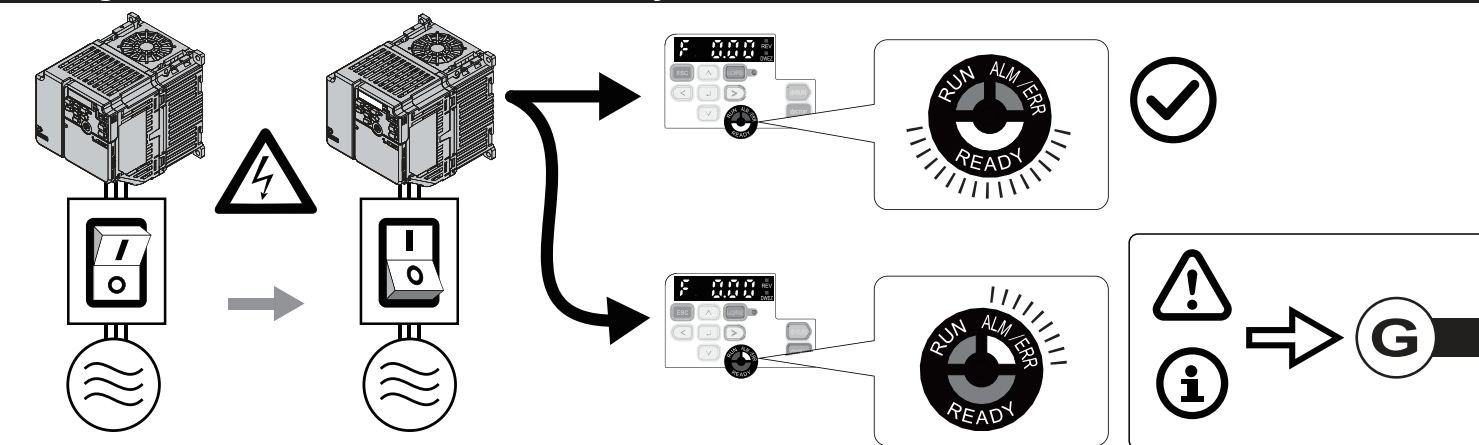

11 Use Auto-Tuning Data from Motor Nameplate to Set Parameters and Auto-Tune the Drive

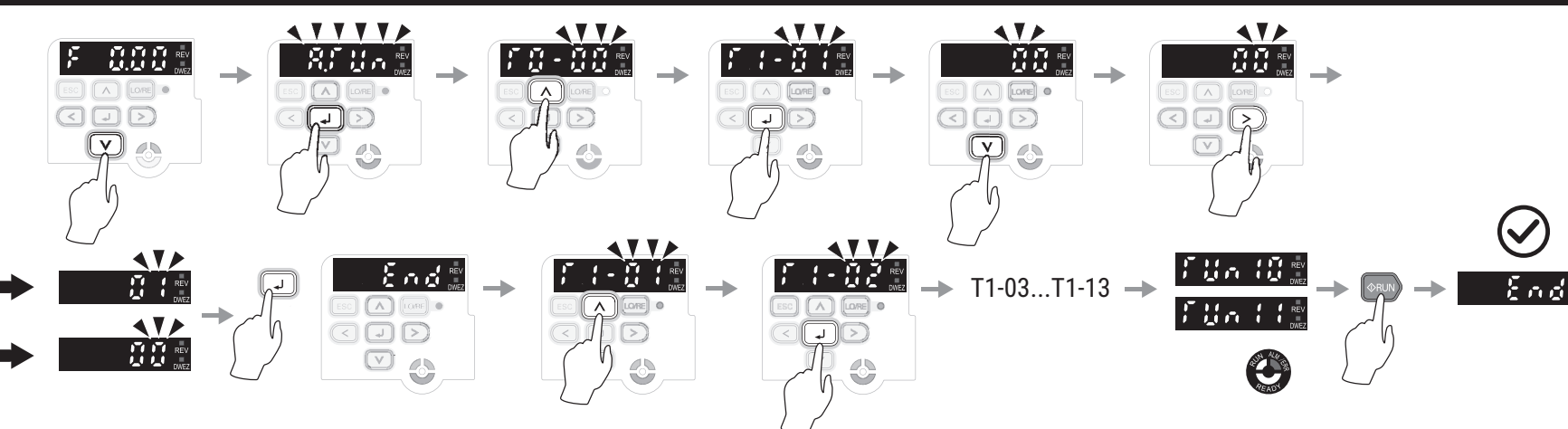

12 Set a Frequency Reference and Check the Motor Rotation Direction

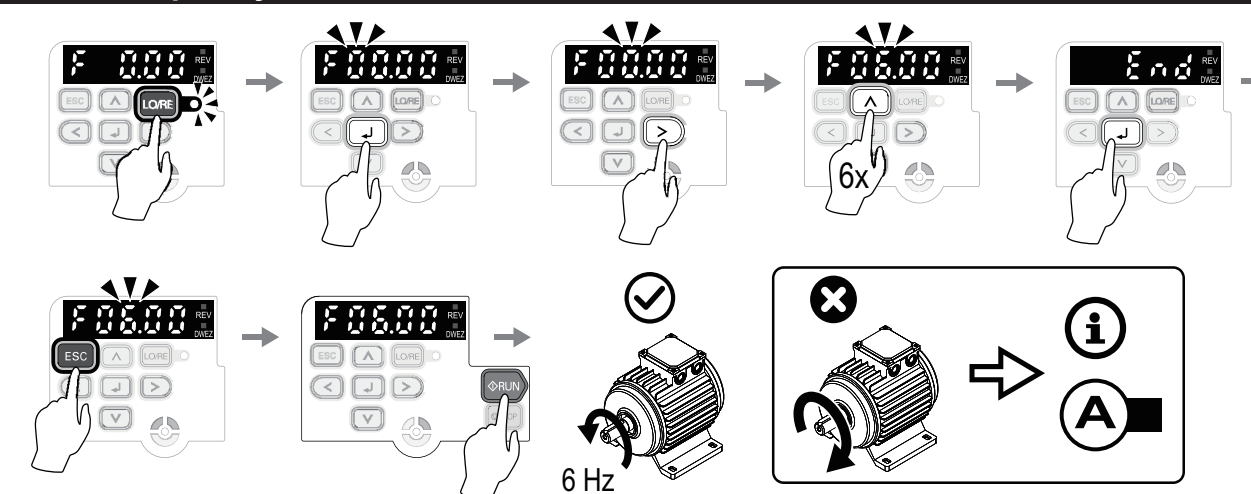

A If the Motor Does Not Rotate in the Correct Direction

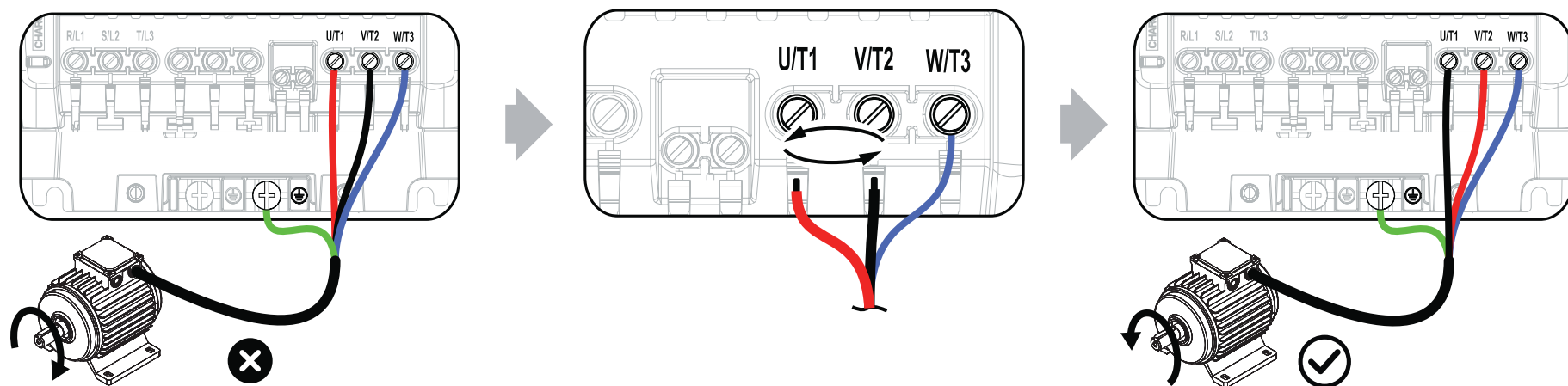

B Control Circuit Configuration and Accessibility

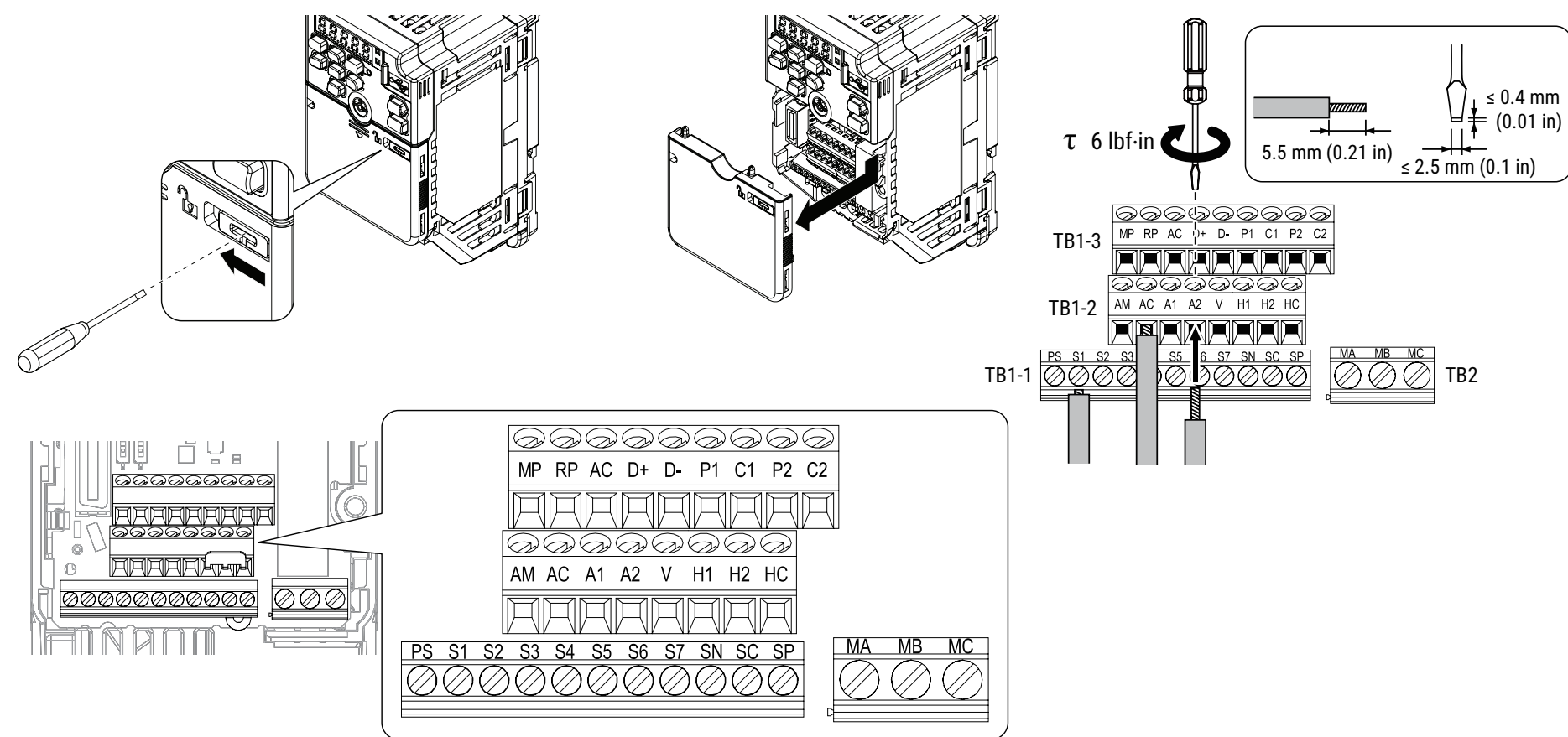

C Switches and Jumpers on the Control Board

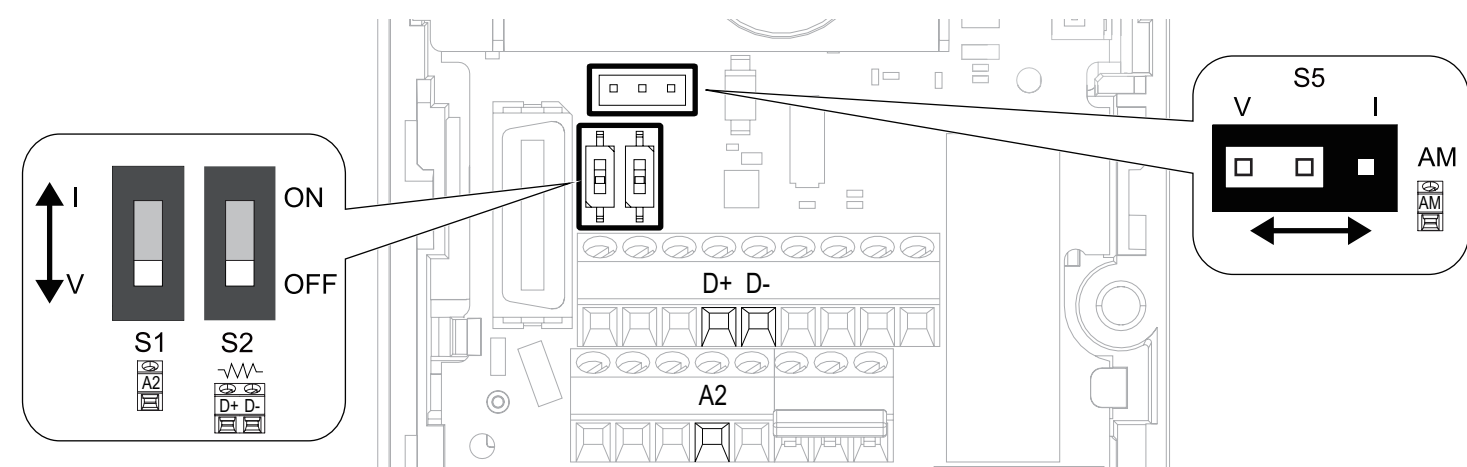

D Connection Diagram and Terminal Functions

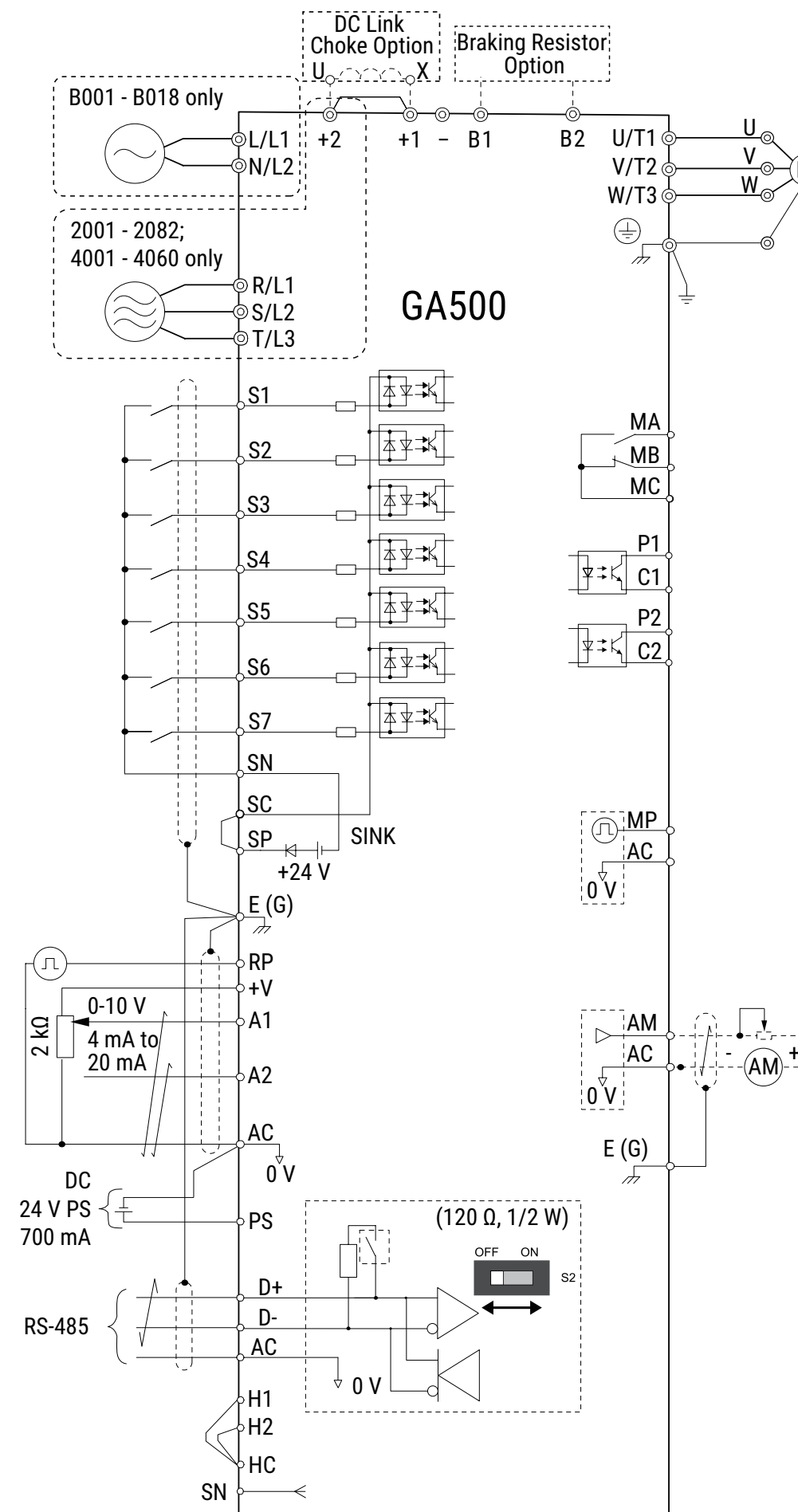

Terminal	Type	Signal Level	Default
S1	MFDI selection 1		Forward run/Stop
S2	MFDI selection 2		Reverse run/Stop
S3	MFDI selection 3		External fault (N.O.)
S4	MFDI selection 4	Photocoupler 24 V, 6 mA	Fault reset
S5	MFDI selection 5		Multi-step speed reference 1
S6	MFDI selection 6		Multi-step speed reference 2
S7	MFDI selection 7		Jog command
SN	MFDI power supply 0 V		-
SC	MFDI selection common	24 V, 150 mA maximum	-
SP	MFDI power supply +24 Vdc		-
H1	Safe Disable input 1	24 V, 6 mA Internal impedance: 4.7 kΩ	-
H2	Safe Disable input 2	Minimum OFF time: 3 ms	-
HC	Safe Disable function common	Safe Disable function common	-
RP	Master frequency reference pulse train input	Response frequency: 0 ~ 32 kHz H level duty: 30 ~ 70% H level voltage: 3.5 ~ 13.2 V L level voltage: 0.0 V ~ 0.8 V Input impedance: 3 kΩ	-
+V	Power supply for frequency setting	10.5 V (20 mA maximum)	-
A1	MFAI 1	0 V ~ 10 V/100% (input impedance: minimum 15 kΩ) -10 V ~ +10 V/-100% ~ +100% (input impedance: minimum 15 kΩ)	Master frequency reference
A2	MFAI 2	0 V ~ 10 V/100% (input impedance: minimum 15 kΩ) -10 V ~ +10 V/-100% ~ +100% (input impedance: minimum 15 kΩ) 4 mA ~ 20 mA/100%, 0 mA ~ 20 mA/100% (input impedance: 250 Ω)	Combined to terminal A1
AC	Frequency reference common	0 V	-
E(G)	Connect shielded cable		-
MA	N.O. output	30 Vdc, 10 mA ~ 1 A	Fault
MB	N.C. output	250 Vac, 10 mA ~ 1 A	Fault
MC	Digital output common	Minimum load: 5 V, 10 mA	-
P1	Multi-function photocoupler output 1		During RUN
C1	Multi-function photocoupler output 1	Photocoupler output 48 V, 2 mA ~ 50 mA	
P2	Multi-function photocoupler output 2		Speed agree 1
C2	Multi-function photocoupler output 2		
MP	Pulse train output	32 kHz maximum	Output frequency
AM	Analog monitor output	0 V ~ +10 V/0% ~ 100% 4 mA ~ 20 mA (receiver recommended impedance: 250 Ω)	Output frequency
AC	Monitor common	0 V	-
PS	External 24 V power supply input	21.6 Vdc ~ 26.4 Vdc, 700 mA	-
AC	External 24 V power supply ground	0 V	-
D+	Communication input/output (+)	MEMOBUS/Modbus, RS-485	-
D-	Communication output (-)	115.2 kbps maximum	-
AC	Shield ground	0 V	-

MFDI: Multi-Function Digital Input
MFAI: Multi-Function Analog Input

E Parameter Groups



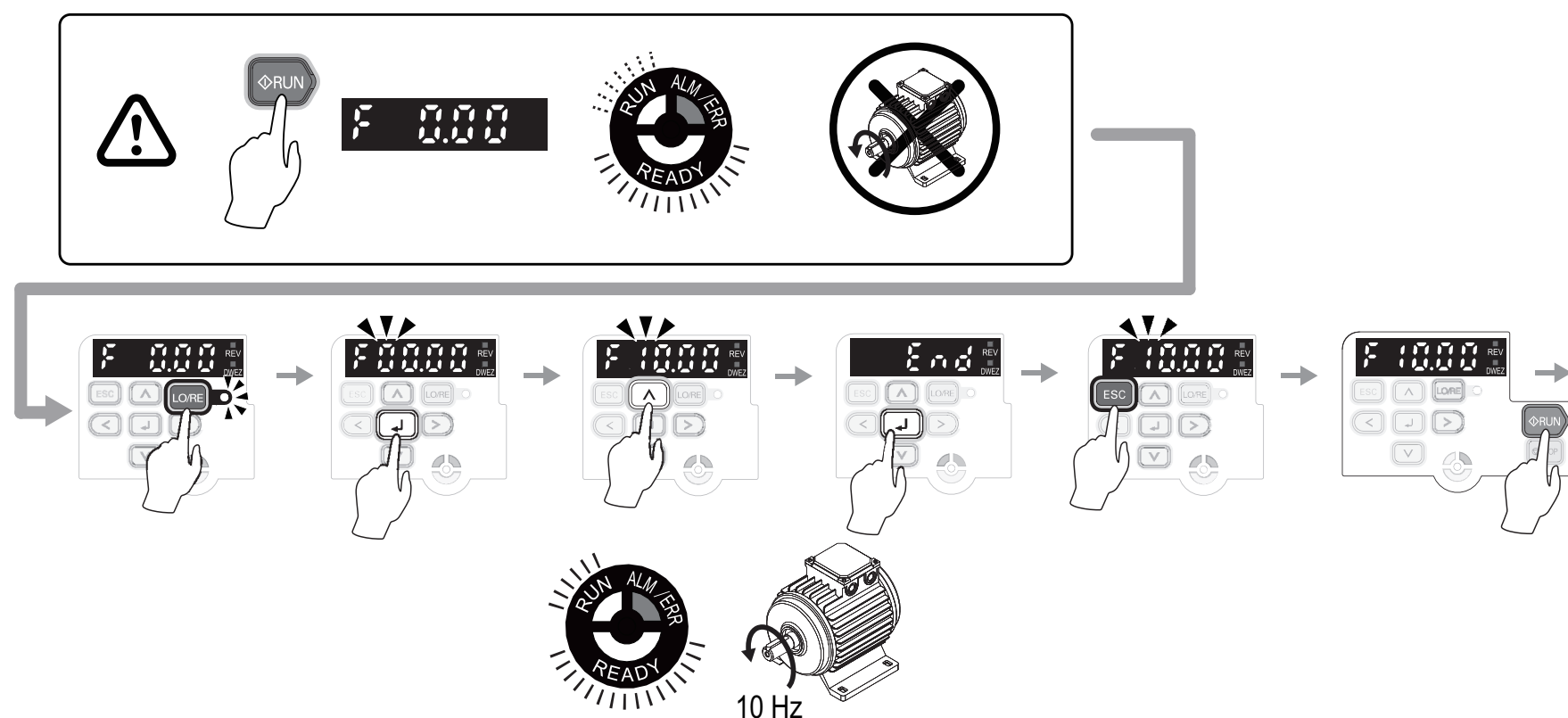

A: Initialization Parameters		d: Reference Settings		H: Terminal Functions		n: Special Adjustment		q: DriveWorksEZ Parameters	
A1	Initialization	d1	Frequency Reference	H1	Digital Inputs	n1	Hunting Prevention	r: DWEZ Connection 1-20	
A2	User Parameters	d2	Reference Limits	H2	Digital Outputs	n2	Auto Freq Regulator (AFR)	T: Motor Tuning	
b: Application		d3	Jump Frequency	H3	Analog Inputs	n3	High Slip/Overexcite Braking	T0	Tuning Mode Selection
b1	Operation Mode Selection	d4	Frequency Ref Up/Down & Hold	H4	Analog Outputs	n5	Feed Forward Control	T1	Induction Motor Auto-Tuning
b2	DC Injection Braking and Short Circuit Braking	d6	Field Weakening/Forcing	H5	Modbus Communication	n6	Online Tuning	T2	PM Motor Auto-Tuning
b3	Speed Search	d7	Offset Frequency	H6	Pulse Train Input/Output	n7	EZ Drive	T3	ASR and Inertia Tuning
b4	Timer Function	E: Motor Parameters		H7	Virtual MFIO Selection	n8	PM Motor Control Tuning	T4	EZ Tuning
b5	PID Control	E1	V/f Pattern for Motor 1	L: Protection Functions		nA	PM Motor Control Tuning	U: Monitors	
b6	Dwell Function	E2	Motor Parameters	L1	Motor Protection	o: Keypad-Related Settings		U1	Operation Status Monitors
b8	Energy Saving	E3	V/f Pattern for Motor 2	L2	Power Loss Ride Through	o1	Keypad Display	U2	Fault Trace
C: Tuning		E4	Motor 2 Parameters	L3	Stall Prevention	o2	Keypad Operation	U3	Fault History
C1	Accel & Decel Time	E5	PM Motor Settings	L4	Speed Detection	o3	Copy Keypad Function	U4	Maintenance Monitors
C2	S-Curve Characteristics	E9	Motor Setting	L5	Fault Restart	o4	Maintenance Monitors	U5	PID Monitors
C3	Slip Compensation	F: Options		L6	Torque Detection	o5	Log Function	U6	Operation Status Monitors
C4	Torque Compensation	F1	Fault Detection in PG Speed Control	L7	Torque Limit			U8	DriveWorksEZ Monitors
C5	Automatic Speed Regulator (ASR)	F6	Communication Options	L8	Drive Protection				
C6	Duty & Carrier Frequency	F7	Communication Options						

F If You Push the Run Button but the Motor Does Not Spin

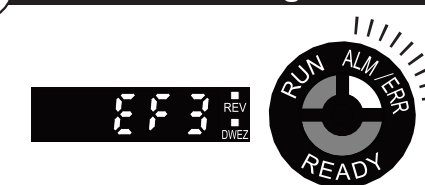

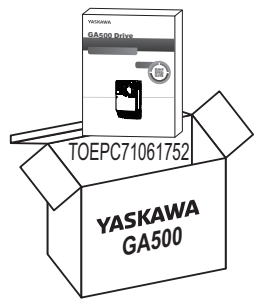
G Troubleshooting Resources for Drive Faults and Alarms

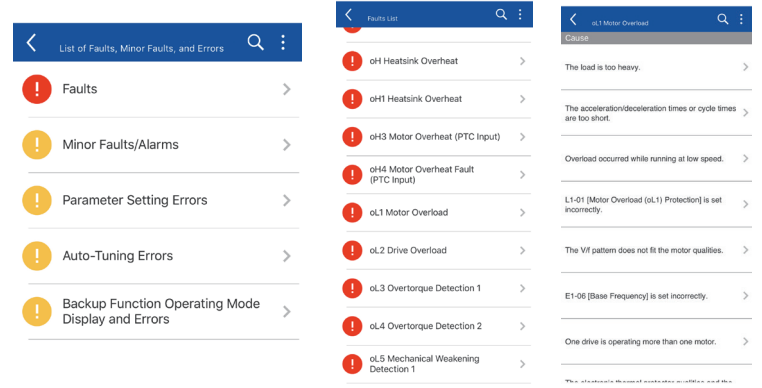
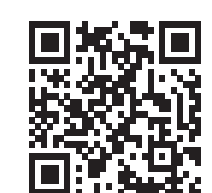

Resource	Choose This When:	URL	QR Code
Installation & Primary Operation	You have access to the paper copy of the manual that was packaged with the drive. This manual lists all drive faults and alarms, and offers a selection of causes and solutions. 	https://www.yaskawa.com/toepc71061752	 PDF download
Mobile App	You want to use your smartphone or tablet and use the embedded help to look up the full complement of causes and solutions to all drive faults and alarms. 	https://www.yaskawa.com/dwm	 App download
Maintenance & Troubleshooting Manual	You want to download a PDF of the manual to your smartphone or tablet. This manual lists the full complement of causes and solutions to all drive faults and alarms and also includes detailed information about drive maintenance, wiring, and programming. 	https://www.yaskawa.com/toepyaiga5001	 PDF download

H Additional Resources



Mobile App



DriveWizard® Mobile Commissioning Smartphone App

<https://www.yaskawa.com/dwm>

Product Manuals



•PDFs
•Online HTML5-Searchable
•Manuals App

<https://www.yaskawa.com/ga500manuals>



I Customer Feedback

Comments or questions about this document? Fill out our online form:



or
Email us: technical_documentation@yaskawa.com
Call us: 1-800-YASKAWA (927-5292)
www.yaskawa.com/DRV-F-0006

Please consider following us on social media:

-  www.youtube.com/yaskawayea
-  www.linkedin.com/company/18822
-  www.twitter.com/yaskawa

Headquarters Address:

YASKAWA AMERICA, INC.
2121 Norman Drive South
Waukegan, IL 60085
USA